

2022

DELIVERING TOMORROW'S  
BODYBUILDING NEEDS TODAY.



Telephone: 0191 4177854  
Fax: 0191 4697763



Heworth House, William  
Street, Gateshead,  
Tyne and Wear, NE10 0JP

[www.jbcomponents.co.uk](http://www.jbcomponents.co.uk)

Welcome  
**contents**



**03**

ABOUT JBL

**04-05**

TEAM & SERVICES

**06-17**

BODY FITTINGS

**18-19**

LIGHTING

**20-23**

GRP PRODUCT & BODY KITS

**24**

FABRICATION



A few words  
About JBL

---

Part of the Service Metals Group.

# S E R V I C E M E T A L S

---

The largest independent stockist of aluminium sheet metal  
for the Road Transport Industry.

## About JBL

JB components Ltd t/a JBL, are part of the successful Service Metals group, which was established in 1976. The Group has grown to become Europe's leading independent supplier of aluminum extrusion and sheet for the road transport associated engineering industries.

Alongside these core products the group also carry a range of steel sections, timber flooring, dry freight & composite panels and a selection of commercial vehicle body fittings and lighting products, in short everything required for the commercial vehicle bodybuilder.

The Fabrication facilities within the group cover a wide range of products from the manufacture of commercial vehicle roofs, roller shutters, aluminum and steel rear frames, flush door systems and a variety of other fabrications to suit custom requirements.

A major growth area within the group is the supply and manufacture of kit body systems from 3.5 ton up to 25 ton, our friendly and knowledgeable staff aim to offer excellent customer support and competitive pricing. Most of our people have many years experience in the industry and are always happy to offer help and advice if required.

# Services

Here at JB Components, we don't just sell products, we offer a variety of services which you may be interested in.



## FABRICATION

We offer first class quality products at affordable prices. Bespoke items are available, please contact us with your requirements.



## BODY KITS

We sell complete body kits from the chassis upwards. We aim to take the guesswork out of building 3.5T bodies by supplying pre-configured kits.



## WELDING

We offer a speedy and professional welding service, from mig and tig welding.



## SPECIALIST EXTRUSIONS

We provide a complete solution to all of your extruded aluminium needs. We help with prototyping, provision of samples, production, fabrication, packaging, holding and distributing your product/s.

We are equally confident designing a new bespoke extrusion as we are re-quoting your existing line of extrusions.



## GRP LAMINATE

We stock a range of Brianza GRP in sheet and roll form and we also stock GRP faced plywood and light-weight 3 element panels.



## ROAD TRANSPORT PRODUCTS

We offer a huge variety of road transport goods. So if you can't find what you're looking for feel free to contact us and we'll do our best to source it.



## ROLLER SHUTTERS & REAR FRAMES

Our fabrication department offers aluminium and galvanised rear frames to compliment the groups roller shutter and flush door products.

Find more information: [www.jbcomponents.co.uk](http://www.jbcomponents.co.uk)

# Team

JB Components comprises of 20+ staff members, some of which boast over 30 years experience in the road transport industry.

## STAFF MEMBERS

---

### ***Graham Jones***

Sales Manager

Graham.jones@jblgateshead.co.uk

### ***Karen Davies***

Accounts Manager

Karen.davies@jblgateshead.co.uk

### ***Dan Beegan***

Operations Manager

Dan.beegan@jblgateshead.co.uk

### ***Hannah Beegan***

Engineering Sales Representative

Hannah.beegan@jblgateshead.co.uk

### ***Alan Campbell***

Engineering Sales Representative

Alan.campbell@jblgateshead.co.uk

Eyeplate 1/4"

- 6mm Thickness
- Weight 0.28kg
- 04107 - Zinc Plated
- 04104 - Self Colour

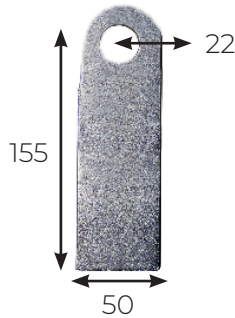

Lashing Ring To Suit V-groove

Product code - 09147

- Manufactured in forged steel
- C/W backing plate & M12 nut
- Load capacity 2.5T
- ZYP finish

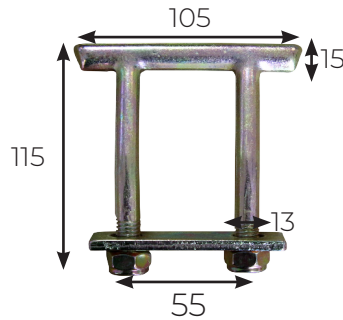

Z.P Recessed Lashing Ring

Product code - 09144

- Spring loaded
- Tensile load - 0.5T
- 4 x 7.3mm fixing holes
- Zinc Plated
- Weight 0.39kg

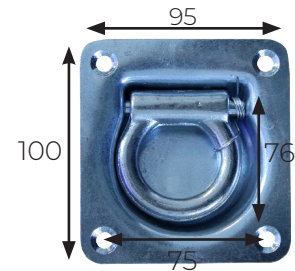

Weld On Lashing Ring

Product code - 03022

- Long plate
- Self colour bracket
- Zinc plated ring
- Tensile load -1T
- Weight 0.65kg

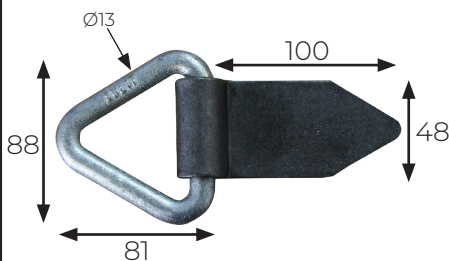

Weld On Rope Hook

Product code - 04083

- Natural finish

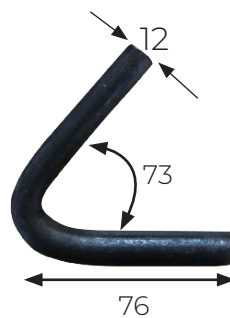

Rope Hook - Bolt On

Product code - 04158

- Manufactured in forged steel
- 2 x 9mm fixing holes
- Zinc plated finish
- Weight 0.17kg

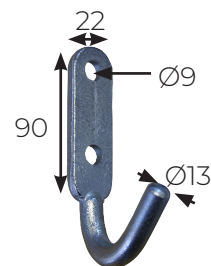

JH7/JH8 Tipping Pillars

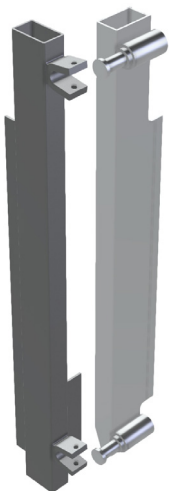

- Aluminium
- Can be powder coated
- To suit hollow plank profile both steel and aluminium
- Can be sold as a pair or individual

Hinge and Gudgeon

Product code - 03182/3

- Pre-threaded backplate
- C/w fitting kit, inc 4 bolts, 2 nyloc nuts & 4 washers.
- Zinc Plated

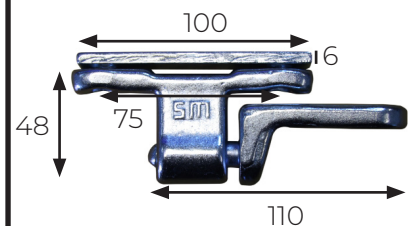

Plastic Grab Handle  
Product code - 10145

- 6mm Fixing Holes
- Black cover caps included



Anti-Luce Fastener  
Product code - 05003

- Zinc Plated
- Comes with nut
- M12
- Weight 100g

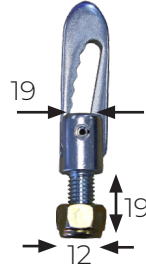

Anti-Luce Fastener  
Product code - 05006

- Zinc Plated
- Comes with nut
- M12
- Weight 140g



Recessed Drop T Handle  
Product code - 24090/1

- Stainless Steel
- Supplied w/ Gasket & 2 Keys
- Cut Out Required: L93, W75 & D65mm
- Depth 66mm
- Weight 0.68kg

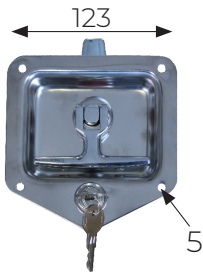

Stirrup Step

- Product code - 0347-11231
- 2mm Galv Steel

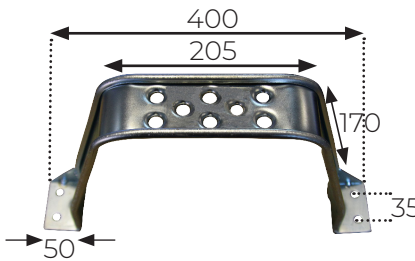

Brewery Droplock Catch  
Product code - DROP84

- 19mm Neck
- 22mm Threaded Shank
- Spring Loaded
- M12 Thread

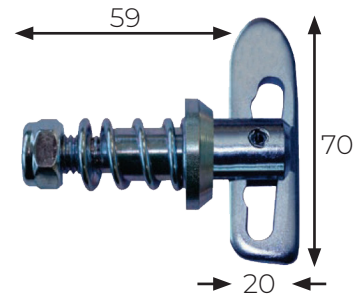

Spring Loaded Bolt

- Zinc Plated

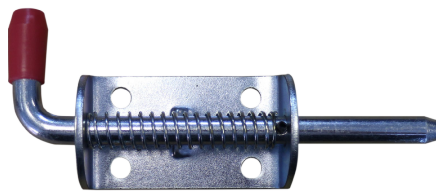

Folding Step

- Product code - 03182/3
- Zinc Plated
  - Max load - 970kg

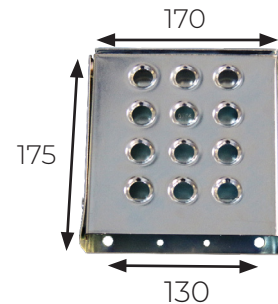

Product Code	Bolt Ø	Fixing Holes	Bracket	Bolt Length
04271	10mm	4 x 5.5mm	L72 x W40	50mm
04268/1	16mm	4 x 6.5mm	L134 x W50	101mm
04265	12mm	4 x 6.5mm	L124 x W40	75mm

Recessed overcentre Lock

Product code - 03152

- Comes with catch plate
- Recess depth: 25mm
- Z/P Lock, w/ self colour catch

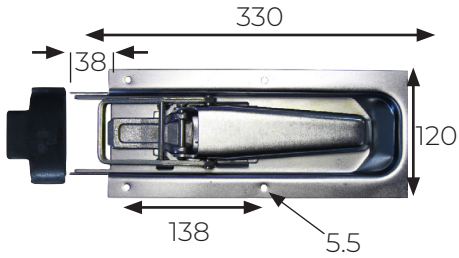

Z/P Barn Door Hinge

Product code - 09200

- Heavy duty 4mm thick door hinge
- Nylon Bushed
- C/w high tensile bolt & nut
- Plate dimensions W:250mm, Hole width 120mm & leg width 65mm

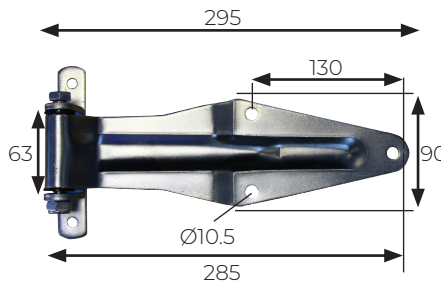

Round Cotter and Wire

Product code - 04247

- Supplied with 190mm wire and 2.5mm ø tab.

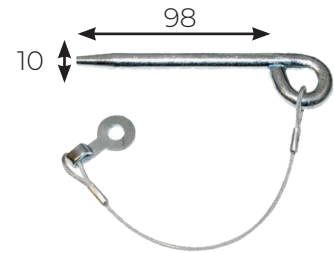

Bolt On Gudgeon

Product code - 09147

- Zinc plated
- Medium duty
- Weight 0.17kg

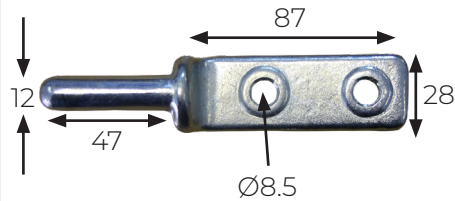

Weld On Gudgeon

Product code - 04067

- Self colour
- Medium Duty
- Weight 0.14kg

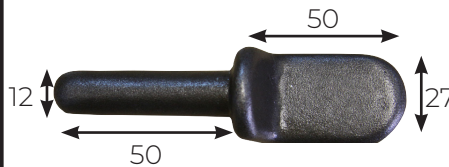

Threaded Gudgeon

Product code - 04158

- Self Colour
- Long Peg
- Weight 0.15kg

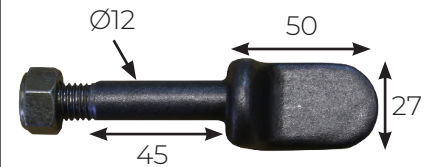

Weld On Hinge

Product code - 04175

- Self Colour
- Medium duty
- Weight 0.53kg

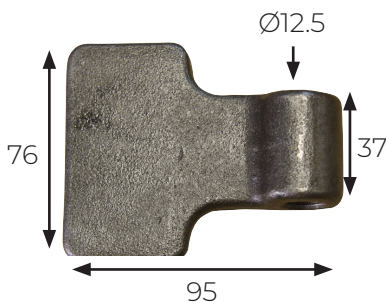

W.O Locking Bar Tab

Product code - 04334/1

- Self Colour
- To suit 20mm lug
- Weight 0.31kg

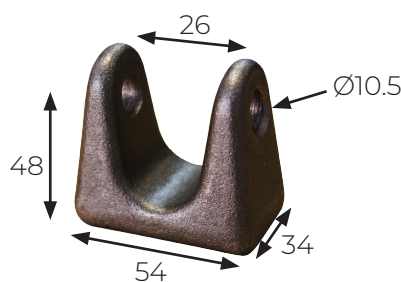

Weld On 3/4" Forket

Product code - 04214/1

- Self colour
- Tensile load - 0.5T
- 4 x 7.3mm fixing holes
- Weight 0.38kg

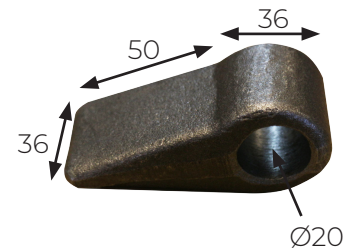



W.O Tailboard Lug

- Left hand & Right hand available
- Self Colour
- Weight 0.6kg
- P/C 04475 (RH) + 04476 (LH)

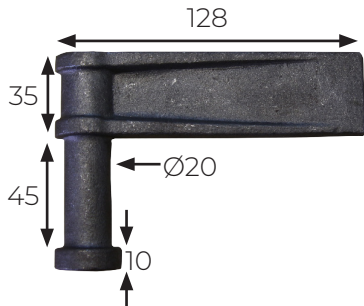

Body mounting bracket - 706B

Product code - 03284

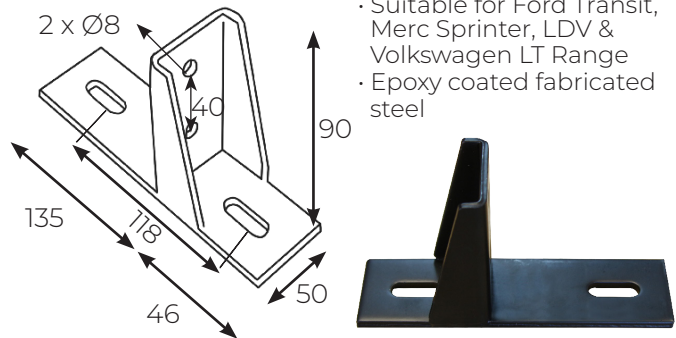

- Suitable for Ford Transit, Merc Sprinter, LDV & Volkswagen LT Range
- Epoxy coated fabricated steel

W.O Tailboard Lug

Product code - 04308/1

- To suit p/c 04334/1
- Self Colour
- Weight 0.36kg

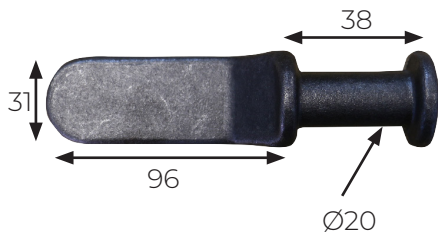

L	A	H	Ø
38	96	31	20

Steel End Cap

Product code - 12523

- Rubber Grommet to suit 17237
- Weight 0.4kg

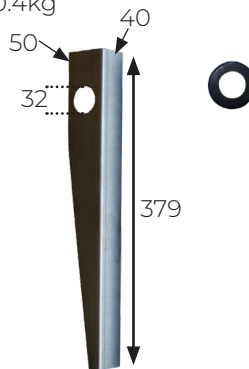

Pin & Chain

Product code - 04245

- Zinc Plated
- Weight 0.14kg

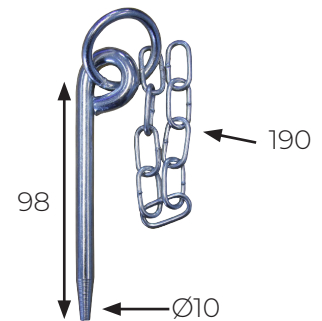

Straight Hinges



Part	Finish	Length	Width	Thick-ness	Hole Dia.	Weight (kg)
04417/2	S/Col	450	30	6	12.5	0.66
04418/2	S/Col	450	40	8	12.5	1.29
04416/2	S/Col	150	40	8	12.5	0.51
04424/2	Zinc P	450	30	6	12.5	0.66
04425/2	Zinc P	450	40	8	12.5	1.29

T-Bar Door Retainer

Product code - 03342

- Stainless Steel
- Plastic Housing
- Suits 03343
- Weight 0.07kg

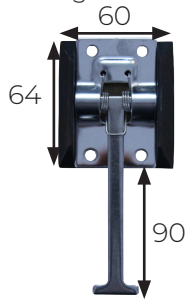

Catch Plate

Product code - 03343

- Stainless Steel
- Plastic Housing
- Suits 03342
- Weight 0.08kg

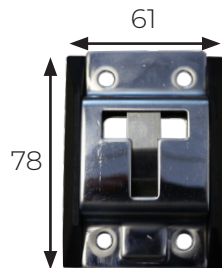

Universal Door Retainer

Product code - 09234/1

- Gold Passivate
- Sprung Loaded
- Grease Nipple
- Suitable for Right & Left Hand Fitment
- Weight 2.3kg

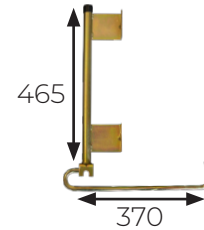

Body Mounting Spring

Product code - 03126

- Yellow Painted
- Suits Mercedes Atego/Axor/ Actros chassis, also suits Iveco & Isuzu chassis.
- Weight 0.11kg

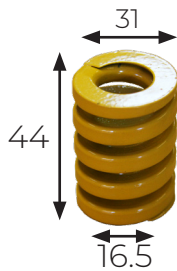

H	ID	OD
44	16.5	31

Purflex

- Single component polyurethane based sealer & adhesive.
- Fast cure, low odour, non toxic
- Excellent adhesion, over paintable & low shrinkage.
- 310mm Cartridge

- Black - 19080/2
- White - 19079/2
- Grey - 19081/2



Red Reflector

Product code - 22690

- Two fixing holes
- Adhesive back
- E Approved

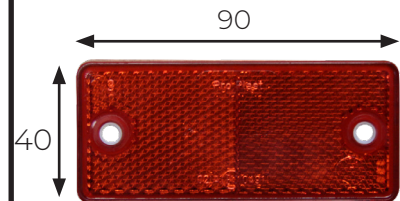

Split Corrugated

- Supplied in a 25mtr Roll
- Temperature Range -25 to 125 °C
- Flame Retardant



Product	Inside Dia	Outside Dia
Scon 1	6.5mm	10mm
Scon 2	10.1mm	13mm
Scon 3	11.8mm	16mm
Scon 4	14.5mm	18.5mm
Scon 5	16.9mm	21.2mm

Spring Hook & Chain

Product code - 03120/1

- Zinc Plated
- Weight 0.09kg

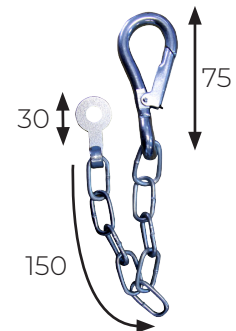

Spray Suppression Flap

Product code - 24090/1

- Type Approved
- Can be supplied with logo. Min req.
- Anti-spray.

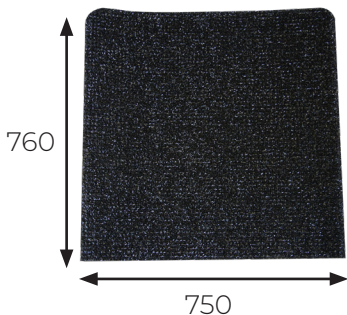

Mudguard Bracket

Product code - 09212

- Suits all 34mm stays
- 9mm Fixing Holes
- Zinc Plated

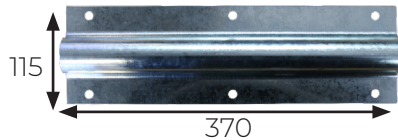

Mudguard Backing Plate

Product code - 09213

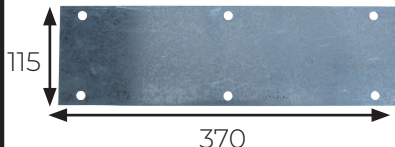

Mudguard bracket

Product code - 03182/3

- Plastic top clamp and backing plate
- Ready assembled for self fitment
- Suits 34mm stay
- 0.61kg per kit of 4 pieces.



Plain Mudflap

Product code - 25150

- Can be supplied with logo. Min req needed
- Variety of sizes available.
- Mounting bracket can be supplied



Embossed Mudflap

- Can be supplied with logo. Min req needed
- Other sizes available.
- Logo and ridges embossed



Rubber Buffer

Product code - 17025

- Round
- Ø6.5mm mounting hole
- Weight 0.03kg

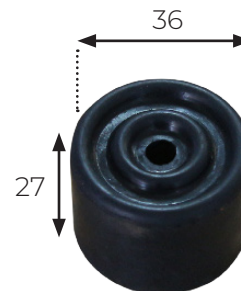

Plastic Ribbed End Cap

Ribbed Inserts both square and rectangular.



On the shelf Sizes:

- 80mm x 40mm
- 100mm x 50mm
- 40mm x 40mm
- 50mm x 20mm
- 50mm x 50mm
- 60mm x 40mm
- 50mm x 30mm

Keruing Flooring



- Hardwood Half Lap
- 22 or 28mm Thicknesses
- Variety of lengths in stock
- 144mm Width
- 10mm Lap

Phenolic Flooring



- Anti-Slip Mesh
- Phenolic Resin Hardwood

Dimensions - 2440 x 1220 or 2500 x 1220

Thickness 12, 15, 18 or 21mm

Other thicknesses available subject to availability

Toolbox

- Variety of sizes
- Logo available subject to numbers



Product Code	Toolbox	Inside Height	Outside Height	Inside Width	Outside Width	Kg
11110	JBX45	290	380	360	450	4.5
11113	JBX52	270	360	430	520	5
11114	JBX65	410	500	565	650	8
11116	JBX80	400	500	720	800	10
11118	JBX100	410	500	920	1000	12
11119	JBX120	400	500	1110	1200	15

Armaton Replacement Handle

- Replacement handles to suit tipper and dropside.
- Product Code:  
51021009 - Dropside  
510410001 - Tipper
- Includes parts and instructions to replace the handle yourself.



Pendulum Console Tipper Pillar



Armaton XF Tipping Pillar

- Handed  
Left Hand - 31434  
Right Hand - 31435
- Requires the tipping pillar (as shown)
- To suit the edge cap in the same height (400mm)



Armaton Rear Corner Pillar

Product code - 31402

- Socket Required for the Rear Pillar



Armaton Edge Cap

- Edge cap required for the corresponding dropside lock.
- Left Hand - 31409  
Right Hand - 31410



Armaton Slotted Edge Cap

Product code - 31407

- Edge cap to suit Pillar.



<p><u>Armaton Rear Corner Socket</u></p> <p>Product code - 31436</p> <ul style="list-style-type: none"> <li>• Socket to suit the Rear Pillar</li> </ul> 	<p><u>Armaton Tipping Pillar Socket</u></p> <ul style="list-style-type: none"> <li>• Socket to suit the tipping pillar 31434 + 31435</li> <li>• Also suits the centre pillar</li> </ul> 	<p><u>Centre Pillar</u></p> <p>Product code - 31402</p> <ul style="list-style-type: none"> <li>• Used in a pair together with the corresponding edge cap</li> </ul> 
<p><u>Armaton Dropside Lock</u></p> <ul style="list-style-type: none"> <li>• Handed</li> <li>Left Hand - 31400</li> <li>Right Hand - 31401</li> <li>• To suit the edge cap in the same height (400mm)</li> </ul> 	<p><u>JBL End Cap</u></p> <ul style="list-style-type: none"> <li>• Handed</li> <li>Left Hand - 03213</li> <li>Right Hand - 03212</li> <li>• Modern Design compared to standard end cap.</li> </ul> 	<p><u>JBL Standard End Cap</u></p> <ul style="list-style-type: none"> <li>• Handed</li> <li>Left Hand - 03218</li> <li>Right Hand - 03219</li> <li>• Comes in different lengths up to 1 meter long</li> </ul> 
<p><u>Corner Pillar</u></p> <p>Product code - 03214</p> <ul style="list-style-type: none"> <li>• Comes in different lengths up to 1 meter long</li> </ul> 	<p><u>Center Pillar</u></p> <p>Product code - 03210</p> <ul style="list-style-type: none"> <li>• Comes in different lengths up to 1 meter long</li> </ul> 	<p><u>HP16 Profile</u></p> <ul style="list-style-type: none"> <li>• Hollow Plank 400mm high</li> <li>• Used as sideboards</li> <li>• Various lengths: 2032, 3990, 4100, 4500mm</li> </ul> 

Welded Ring

Product code - 13020/1

- Suits curtain side centre pole
- Material: 8.3mm diameter

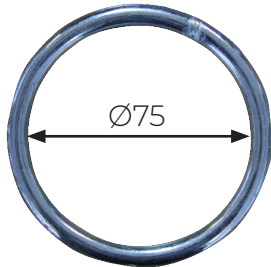

Front Radius Plastic Cap

Product code - CSG5PE

- Suits CP53 Corner Pillar



Rear Plastic Cap

Product code - CSG5PR

- Rear Plastic Cap to suit SG5A Side Guard



Tipper Block

Product code - 30554

- Steel plate
- Depth 30mm

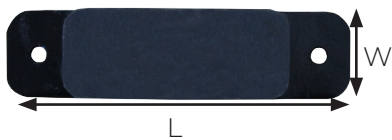

L	W
160	24

6 Mtr Ratchet Strap

Product code - 13070

- Claw Hook
- Other colours and sizes available.

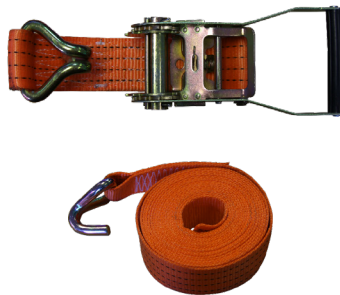

Decking Screw

- Can be used on truck flooring



Product	H	W
01105	38	14
01106	44.45	14

Cleat Bracket

- 4 x 6.5mm holes per bracket
- Sold in pairs
- Suits 100mm runner /100mm bearer

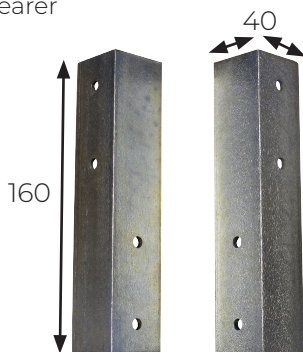

Door Retainer Catch

- Zinc Plated
- Springs are S/Steel

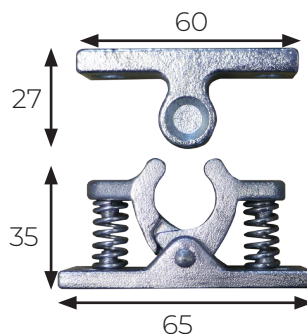

3.5T Universal Coupling

- Zinc Plated/ Clear passivate finish
- 2 x 17mm fixing holes
- Fixed ball
- Weight 3.55kg



Hasp & Staple

Product code - 08043

- Galvanised
- Heavy Duty
- Weight 0.48kg

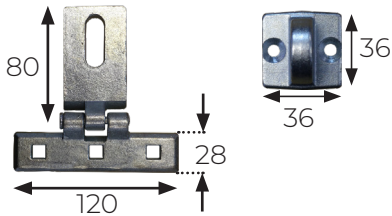

Double Sided Tape

Product code - 09200

- 20mm Width
- 2mm Thickness
- 50m Roll



Fire Extinguisher

- 1kg Powder - P/C 11179
- 2kg Powder - P/C 11178
- Squeeze grip operation
- Clip on base, CE Approved
- Can supply more information if required



2 Rung Retractable Step

Product code - 24090/1

- Punched Tread for extra grip
- Manufactured in steel
- 6 x 11mm Fixing holes
- Weight 6.6kg



3 Rung Retractable

Product code - 0347-11231

- Punched Tread for extra grip
- Manufactured in steel, galvanised finish
- Under body fixing by welding
- Weight 6.6kg

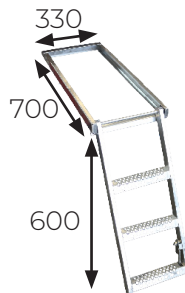

AT600 Ratchet Tensioner

Product code - 505/40AT

- 25mm Shaft with 10mm slot.
- Armour-Tech 600 Surface Coating
- 3 fixing points
- Unique 'direct ratchet drive'

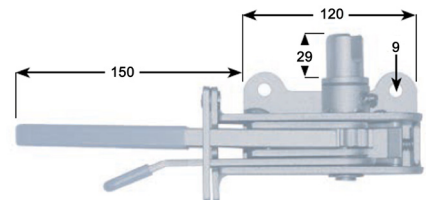

Flettner Vent 2000

- Simple and easy to fit
- Roof ventilator
- Best for small & medium vehicles
- Weight 900g

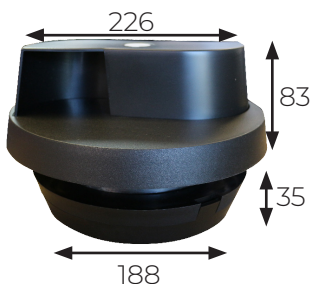

VBG UNDERRUN BAR

- Aluminium Protection Beam
- Includes bolt kit
- Reflective strip
- Attachment for splash protection

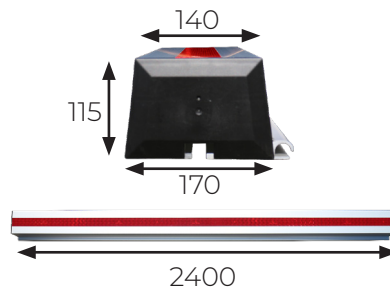

UNDERRUN BRACKETS

- Come undrilled for universal fixing
- Two main types of Endplates
- EUH - Up to 800mm high between chassis and floor
- EUM - More than 800mm high between chassis and floor
- Dimensions & drawings available on request

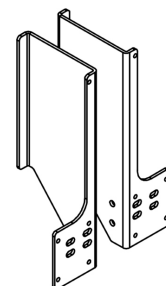

<p><u>Sideguard Leg</u> Product code - 12300/3</p> <ul style="list-style-type: none"> <li>• Adjustable bracket</li> <li>• To suit side guard</li> <li>• Zinc Plated</li> <li>• Weight 2.25kg</li> </ul> 	<p><u>Heavy Duty Tipper Leg</u> Product code - 10005</p> <ul style="list-style-type: none"> <li>• Black Powder Coated</li> <li>• Heavy Duty - Made for off road &amp; quarry work.</li> <li>• Type Approved</li> <li>• To be used with Kit 17.</li> </ul> 	<p><u>Chassis Bracket &amp; Leg</u> Product code - 32406</p> <ul style="list-style-type: none"> <li>• Adjustable length</li> <li>• Heavy Duty</li> <li>• Used on Tipper</li> </ul> 
<p><u>Hinge-Up Side Guard</u> Product code - 12305</p> <ul style="list-style-type: none"> <li>• 160 Degree Lift</li> <li>• Zinc Plated</li> <li>• Variable lift &amp; pin options.</li> <li>• Weight 3.5kg</li> </ul> 	<p><u>CP54 Pedestrian Kit</u></p> <ul style="list-style-type: none"> <li>• Sideguard squared corner pillar</li> <li>• To suit SG5A</li> <li>• Kit comes with 2 x Pillar, 4 x Pillar end caps, 4 x Side guard end caps. 8 x Nuts, bolts, rivets &amp; washers</li> <li>• Can supply in either 500mm or 100mm lengths</li> </ul> 	<p><u>CP53 PEDESTRIAN KIT</u></p> <ul style="list-style-type: none"> <li>• Sideguard radius corner pillar</li> <li>• To suit SG5A</li> <li>• Kit comes with 2 x Pillar, 4 x Pillar end caps, 4 x Side guard end caps. 8 x Nuts, bolts, rivets &amp; washers</li> <li>• Can supply in either 500mm or 100mm lengths</li> </ul> 
<p><u>Chrome Locking Handle</u> Product code - 24004</p> <ul style="list-style-type: none"> <li>• Chrome plated</li> <li>• Comes with two keys</li> </ul> 	<p><u>Locking L Handle</u> Product code - 08100</p> <ul style="list-style-type: none"> <li>• Black Handle</li> <li>• 90 Degrees</li> <li>• Comes with two keys</li> <li>• Mount: W23mm, L70mm</li> <li>• Hole centres 35mm</li> </ul> 	<p><u>Sideguard Replacement Pin</u> Product code - 12306</p> <ul style="list-style-type: none"> <li>• Replacement pin for zinc plated Sideguard leg (12305)</li> </ul> 



Rubber Seal

- Available in 19mm & 21mm
- To suit door panels
- Made from rigid PVC



Red Spring  
Product code - 30999

- Body mounting spring
- Comes with washer

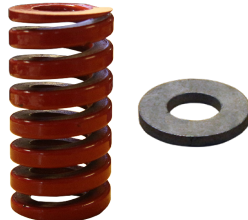

Spring Loaded Sword Pin  
Product code - 04231

- 10mm Diameter
- Brass Toggle & Zinc plated



R40 Ratchet Tensioner  
Product code - 22401/22402

- Popular universal tensioner
- Right & Left hand
- Other Ratchet Tensioners Available

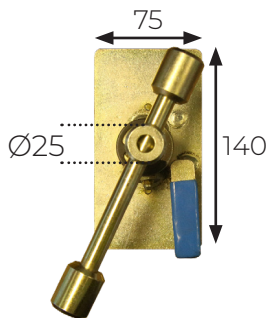

Plastic Mudguards

- Rotationally moulded mudguards with a gloss finish.
- Lightweight & non rusting
- Flexible
- Easily fitted
- Comprehensive range of sizes
- Tell us your tyre size and state if its a double or a single wheel, and we will supply you the correct mudguard for the job



Anodised Ribbed Profile c/w Kinnegrip Catches

- 16" Anodised Profile Planking
- Supplied with Kinnegrip catches
- Removes the need for a corner pillar
  - Stylish look
- Available in two lengths 4115 & 2135
- Standard end caps also available



Blaze Beacon 12v  
Product code - 22665

- Rotator
- R65 Approved
- 2 Bolt
- Weight 5kg
- Amber

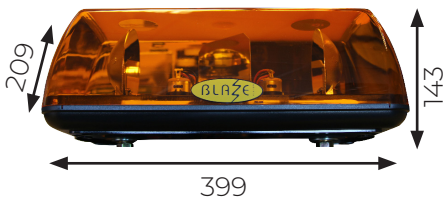

LED Beacon12/24v  
Product code - 22693

- R65 & R10 Approved
- Single Bolt
- Weight 0.8kg
- Fixed Din
- Flash Rate: 120 FPM
- Amber

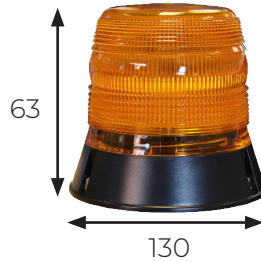

LED Beacon Flexi 12/24v  
Product code - 22692

- R65 & R10 Approved
- Flexi Din
- Weight 1kg
- Flash Rate: 120 FPM
- Din Pole Mount



Rear LED Marker  
Product code - 22731

- Multivolt 12-24v
- 50cm Hardwired Cable
- 12mm Thickness
- Colour: Red

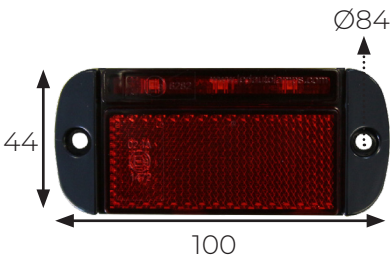

Amber LED Marker  
Product code - 22678

- Multivolt 12-24v
- 50cm Hardwired Cable
- 12mm Thickness
- Colour: Amber

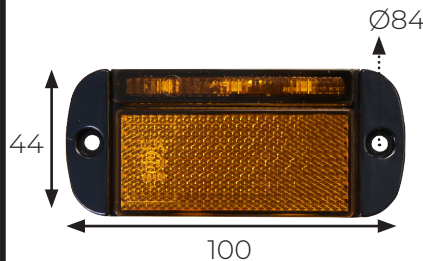

Front LED Marker  
Product code - 22732

- Multivolt 12-24v
- 50cm Hardwired Cable
- 12mm Thickness
- Colour: White

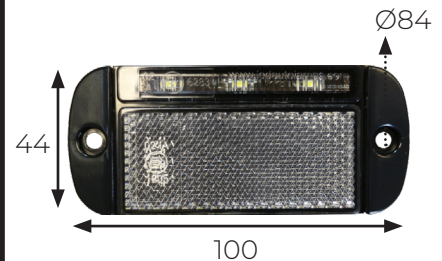

Pendant Bracket  
Product code - 22679

- Suits LED Markers Above



5 LED Mag-Mount Work Lamp

- Clear Lens, 10w
- 5 x 2w LED, 700 Lumens
- 3m Cable Length
- Height of lamp inc handle 170mm



6 LED Cube Work Lamp

- Clear Lens, 18w
- 6 x 3w LED, 1500 Lumens
- 480mm Cable Length



Round 95mm LED Light

- E Approved
- Dual Voltage 10-33v
- Low Power
- 95mm Surface Mount base available.

Part Number	Function	Reflector	Watts
RCV4500	Stop & Tail	Red	2w Stop 0.5w Tail
RCV4507	Stop & Tail	Clear	2w Stop 0.5 Tail
RCV4501	Front/Rear Indicator	Clear	2w Indicator
RCV4506	Front/Rear Indicator	Amber	2w Indicator
RCV4502	Stop, Tail & Indicator	Clear	2w Stop 0.5w Tail
RCV4503	Rear Fog	Red	2w Fog
RCV4508	Rear Fog	Clear	2w Fog
RCV4504	Front Position & Indicator	Clear	1.5w Position 0.5 Indicator
RCV4510	Reverse	Clear	1.5w Reverse



HS L  
80 95

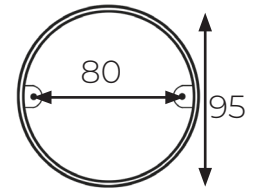

LED LIGHT BAR

- Magnetic Mount - p/c 22224
- Bolt Mount - p/c 22223
- Cable Length - 2300mm
- Reg 65 Approved
- Programmable flash pattern
- 39w, 56 x 0.5w LED



12V High Mount Stop Lamp

- 40cm Hardwired Cable
- Fully waterproof
- Current Draw @ 13.8v 0.16Amps
- ECE S3 Approved
- 16mm Thickness
- Bracket cut out 203 x19mm
- Lamp p/c 235RHM12E
- Bracket p/c 235B1B



Number Plate Light

- Chrome Finish
- Fully waterproof
- 40cm Hardwired Cable
- Current Draw @13.8 Volts
- 30mm width

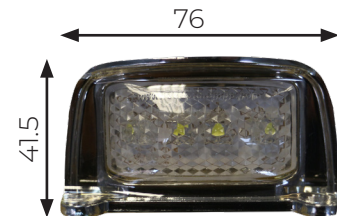

LED Stalk Lamp

- Right Hand p/c 840/01/04
- Light Hand p/c 840/01/05
- 12/24v
- 70mm Hole centers

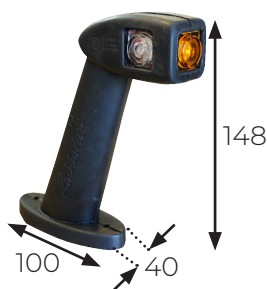

Compact LED Work Lamp

- 700 Lumen Output
- Four Diode Flood Light Pattern
- ECE R10 Approved
- Multivoltage: 9 - 36Vdc



TYRI Work Lamp

- 700 Lumens
- IP 69K, EMC Tested
- Light pattern, symmetric, asymmetric, high, spot, fog
- Depth 82.40mm
- 12/24v



## Brianza Plastica GRP Laminate

### Laminate Rolls

As sole distributor of Brianza Plastica products in the UK & Ireland we offer fibre-glass laminates in sheet and roll form to the vehicle bodybuilding sector. We stock a large range of both roll and sheet materials for the panel manufacturing and engineering industries.

The laminate is suitable for the production of insulating panels for recreational vehicles and temperature controlled vehicles.

### Elycold

Elycold comes from the combination of polyester resin and glass fibre; which provides manufacturers with excellent long-term technical resistance, UV protection and total impermeability and insulation protection inside the panel.

The stability of the laminates is guaranteed by the use of fiberglass chipped strand mat, which can be combined with woven roving reinforcement to further improve the mechanical features of the laminate.

### Elycold Availability

#### Sheet form

4mm

7.315 x	6.100 x	5.500 x	4.300 x	3.000 x	2.750 x	2.500 x
2.440	2.440	2.440	2.440	2.440	2.440	2.440

#### Roll Form

Mat & Woven Roven finish available.

Typically 60m

Film grooved standard finish, which improves bonding performances, and also come with a protective film on to reduce damages during handling.

For more product information feel free to contact us or visit our website [www.jbcomponents.co.uk](http://www.jbcomponents.co.uk)





## GRP PANELS

### GRP & ECOFONT

We are also a stockist and distributor of polyfont panels, which can be supplied to meet your size requirements.

GRP faced plywood available in the following thicknesses - 11mm, 14mm, 17mm, 20mm & 24mm.

### ECOFONT - LIGHTWEIGHT PANEL

A lightweight 3 element panel, specifically designed for its aesthetic and weight saving properties. The ecofont panel is available in any size you require.

*Composition:* Gelcoat, GRP, high density recyclable foam, grp white gelcoat.

## BODY KITS

Bespoke & competitively priced body kits.

Our standard Bodykits include:

- Curtainsider Bodykit
- Steel Tipper Bodykit
- Aluminium Tipper Bodykit
- Box Van Bodykit
- Luton Bodykit
- Aluminium Dropside Bodykit

To help keep costs to a minimum we use a standard range of extrusions to manufacture the kit, and also to help keep the cost down on any replacement parts.

Bespoke kits to suit your requirements.

## HOOKED PROFILE DROPSIDE

### AS STANDARD

- Kinnegrip End Caps
- Laser Headboard
- One Piece Floor
- Anodised Profile
- V-Groove Side Rave
- Recessed Lashing Rings
- Armaton Dropside Pillar

### OPTIONAL

- Toolbox / Cabbox
- Access Steps
- Camera Systems
- Work Lamps
- LED Lightbars
- Fall Arrest Systems
- Armaton End Caps / Pillars
- Personalised Headboard



## STEEL TIPPER

### AS STANDARD

- Steel Floor
- Laser Headboard
- Double Skinned Profile
- JBL Steel Tipping Pillar
- Steel Wings
- Tailgate Protector
- Steel End Caps

### OPTIONAL

- Mudwings
- Side Access Step
- Camera Systems
- Work Lamps
- Reverse Alarm
- LED Lightbars
- Armaton Tipping Pillar
- Personalised Headboard
- Cab Toolbox



## HP16 ALLOY DROPSIDE

### AS STANDARD

- Flush-Fit End Caps
- Laser Headboard
- One Piece Floor
- Anodised Profile
- V-Groove Side Rave
- Recessed Lashing Rings

### OPTIONAL

- Kinnegrip End Caps
- Access Steps
- Camera Systems
- Work Lamps
- Toolbox / Cabbox
- Alloy Flooring
- LED Lightbars
- Fall Arrest Systems
- Armaton End Caps
- Personalised Headboard



## ALLOY TIPPER

### AS STANDARD

- Steel Floor
- Laser Headboard
- Kinnegrip End Caps
- JBL Tipping Pillar
- Hooked Anodised Profile

### OPTIONAL

- Mudwings
- Side Access Step
- Camera Systems
- Work Lamps
- Powder-coated Profile
- Cab Toolbox
- LED Lightbars
- Armaton Tipping Pillar
- Armaton End Caps
- Personalised Headboard
- Alloy Plank Flooring



## FABRICATION

### Fabrication Service

Within our branch we have the ability to fabricate specialised items.

- State of the art brake press - Up to 4.1 meters
- Guillotine
- Welding - Mig & Tig
- Plasma Cutting
- Cutting Facilities - Aluminium, Timber and Steel

### Examples of Fabricated Items we produce

#### Alloy CAB BOX

- Made to your desired specifications
- Shelving Optional
- Graphics can be supplied on orders of 10+
- Yale lock or Hasp and Staple
- Option of door instead of roller shutter
- GRP Toolbox also available



#### Roofs

- Made to your specifications
- Aluminium framed roofs for box vans
- Fibreglass roof sheets

#### Steel Sections

- Bent to any specification
- Different lengths available
- Different heights available

#### Headboards

- Alloy or Steel
- Laser cut to your design spec
- Designed in house using CAD software



#### Bespoke Products

Using our specialised design service and dedicated fabrication team we aim to fulfil any of your fabrication needs. So please get in touch and let us help you design and fabricate the parts to complete your project.



W E A R E

